



INSTALLATION GUIDE

For Harley-Davidson Cable Actuated
Sportster

Doc ID: 191-2815006A
Revision: 081220

Table of Contents

OVERVIEW	3
INSTALLATION TIPS	3
TOOLS.....	3
INCLUDED PARTS	5
BEFORE YOU BEGIN.....	6
DISASSEMBLE CLUTCH.....	6
INSTALL THE CLUTCH PACK	11
INSTALL THE PRESSURE PLATE.....	12
FINISH INSTALLATION	14
RESET THE LEVER FREE PLAY	19
BREAK IN THE NEW CLUTCH.....	20
MAINTENANCE.....	20
Disk inspection examples.....	21
TROUBLESHOOTING	22
Performance issues.....	22
Clutch Drag	22
Clutch Slip	22
NEED ADDITIONAL HELP?.....	23

OVERVIEW

This kit replaces the OE (Original Equipment) or “stock” clutch pack.

- This kit will replace all the OE drive plates and friction plates

INSTALLATION TIPS

- Read the separate included Safety Information document before operating the vehicle with the product installed.
- Read this entire document before performing any steps.
- If you install this product for a customer or another person, instruct them to read the **Safety Information** document and the **Installation and User Guide** before operating the bike with the product.
- Videos related to this product can be viewed online at www.rekluse.com/support/videos.
- Protect eyes and skin – wear safety glasses and work gloves. Work in a well ventilated area.
- Use the torque values listed in the instructions. Otherwise, use the torque specifications found in your OE service manual.
- Visit www.rekluse.com/support for a full parts fiche illustration and part numbers.
- For optimal clutch performance Rekluse recommends using fresh, clean oil that **meets JASO-MA** oil rating requirements. Rekluse offers Factory Formulated Oil™ developed specifically for Rekluse products. Rekluse Factory Formulated Oil is a perfect complement to any OEM or aftermarket wet clutch. Visit www.rekluse.com to learn more.

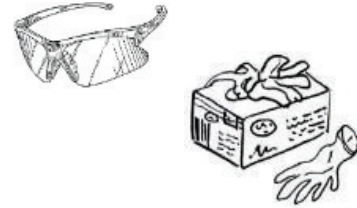

TOOLS

- 1/4” hex key
- 1 1/8” socket

- 5/16" hex key
- 3/16" hex key
- 5 mm hex key
- 5/32" hex key
- 5/8" open-end wrench
- 9/16" open-end Wrench
- 1/2" open-end wrench
- 7/8" open-end wrench
- Snap ring pliers
- Pliers
- 1 3/16" socket
- Torque wrench
- Telescoping magnet
- Dental pick
- Shop/bench press
- Conventional oven
- T27 Torx bit
- Impact gun
- Flat head screwdriver

Additional tools available for purchase at a local dealership:

- Primary wedge tool
- Clutch spring removal tool

INCLUDED PARTS

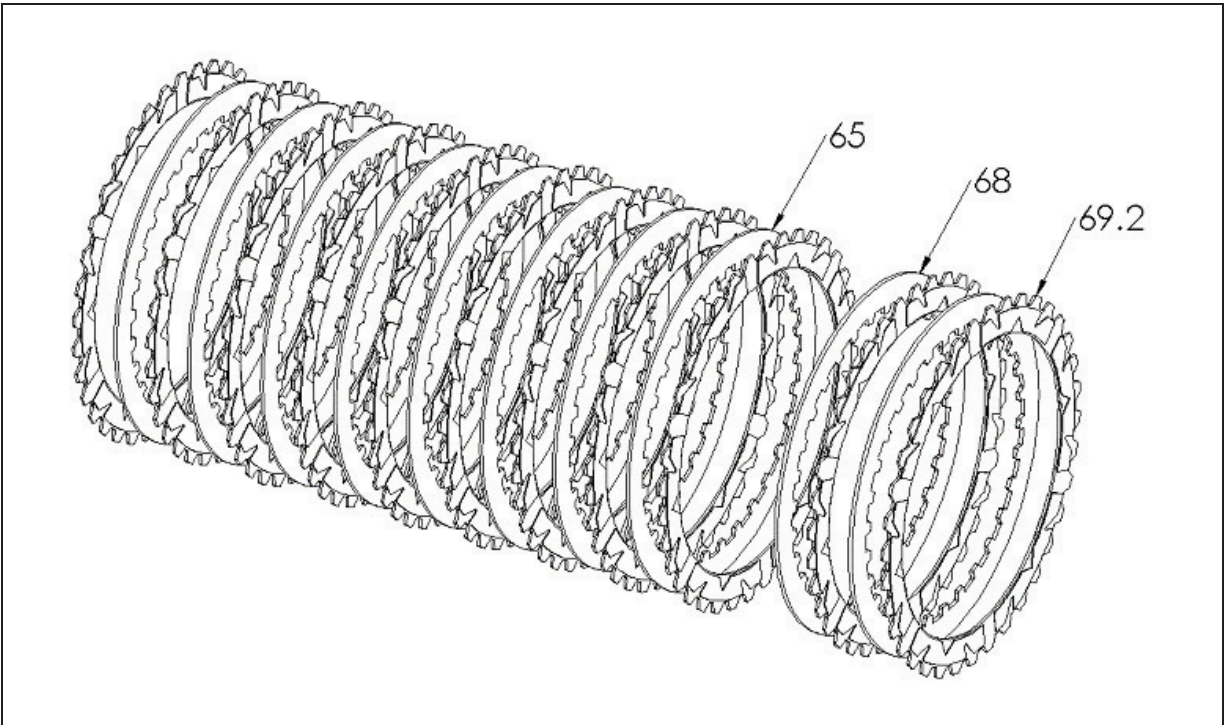

Item	Description	Qty.
65	Steel drive plates - .048" (1.2 mm)	8
68	Steel drive plates - .060" (1.5 mm)	2
69.2	Friction disks – Rekluse TorqDrive®	11

BEFORE YOU BEGIN

- Rekluse recommends replacing the chaincase cover gasket when installing this product.
- The OE basket bearing may need to be replaced if it shows signs of excessive wear.

DISASSEMBLE CLUTCH

1. Fully collapse the in-line cable adjuster, so that the clutch lever becomes very loose at the perch. This removes the tension on the clutch cable during disassembly and installation.

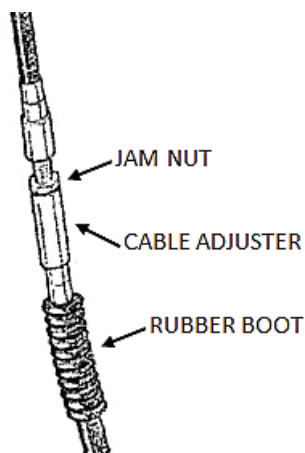

2. Soak the friction disks in new primary transmission oil for 5 minutes. Make sure the Friction disks are coated on both sides.

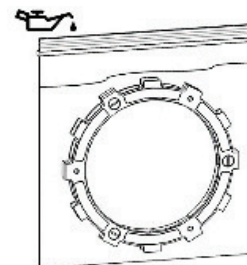

3. Stand the bike up on a suitable bike stand or lift.



4. On the primary chain case, use a 5/8" wrench to remove the oil drain plug, then drain the oil into a

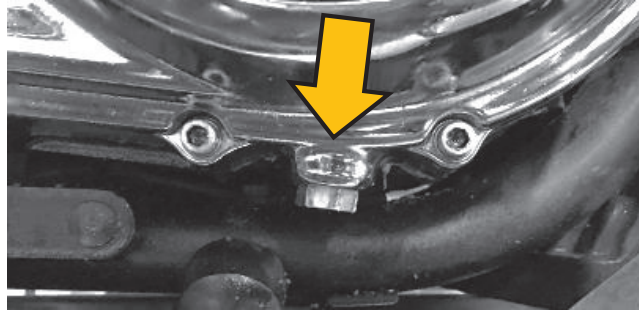

suitable container.

5. Loosen the chain tensioner lock nut, then turn the chain tensioner adjustment bolt **counterclockwise** until it spins freely.

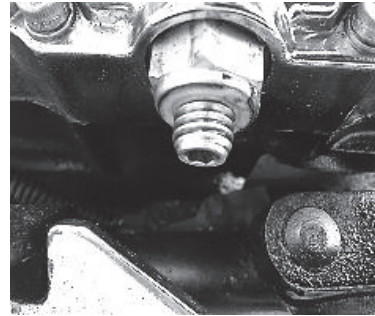
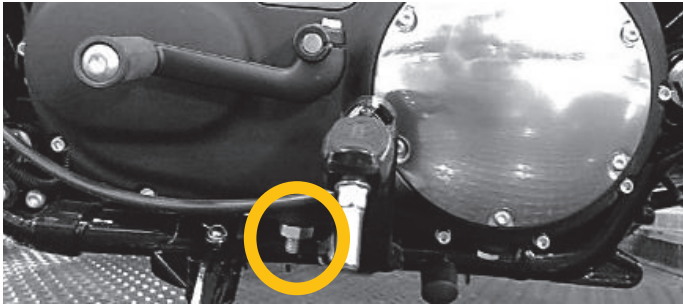

6. Shift the bike into 5th gear, then remove the shift lever off its shaft and set it aside.

7. Remove any footboards that block the primary case and set them aside.

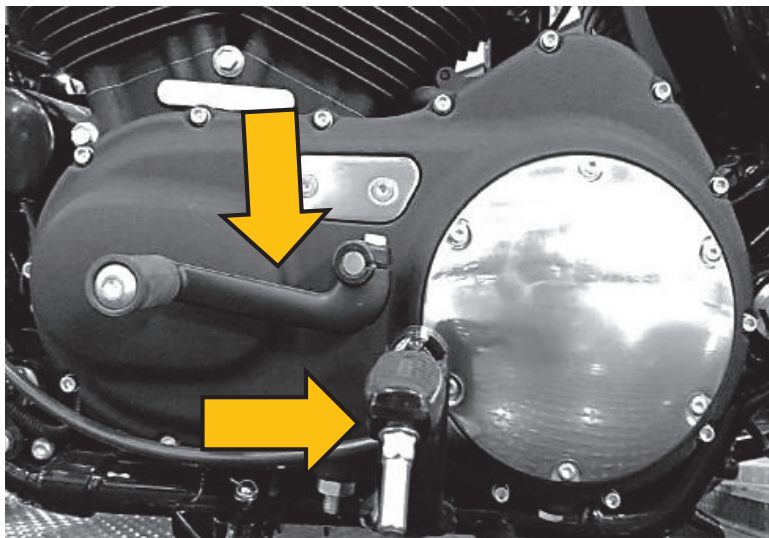

8. Remove the derby cover and the O-ring gasket.

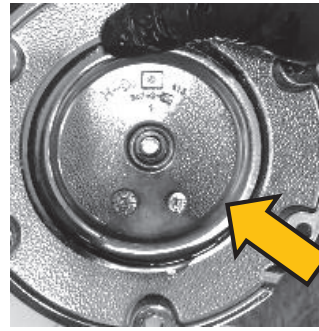
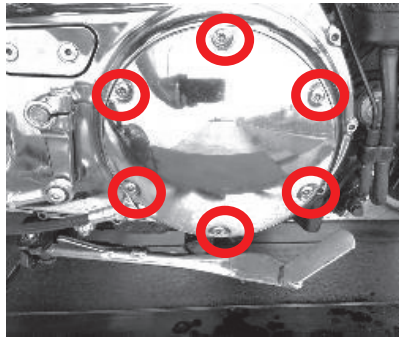

9. Remove the spring and the jam nut from the actuating mechanism. Set these aside.

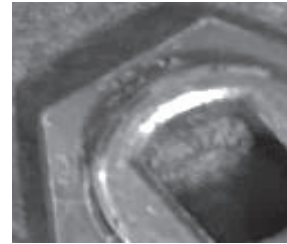
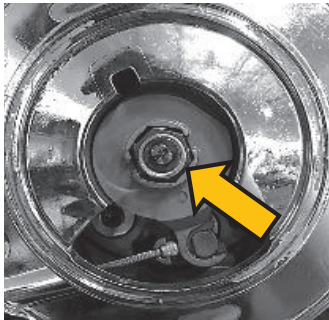

10. Use a flat blade screwdriver to turn the threaded stud **clockwise** to remove the nut. Set it aside.

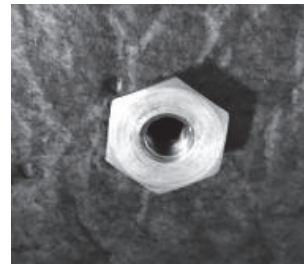
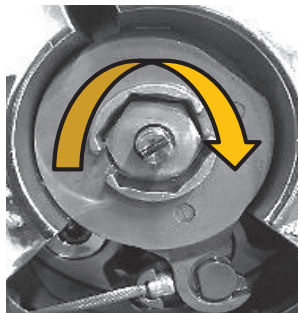

11. Clear a space below the primary gasket cover to set the cover once it is removed. Remove the primary case cover and the cover gasket.

Note: *The attached clutch cable limits where you can set the primary cover when it is removed.*

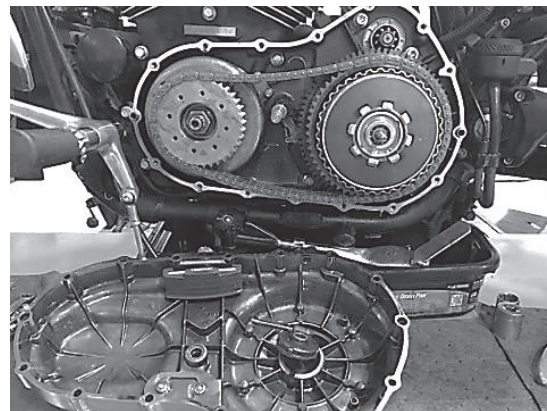

12. Hand thread the clutch spring compressor tool onto the throw-out rod.

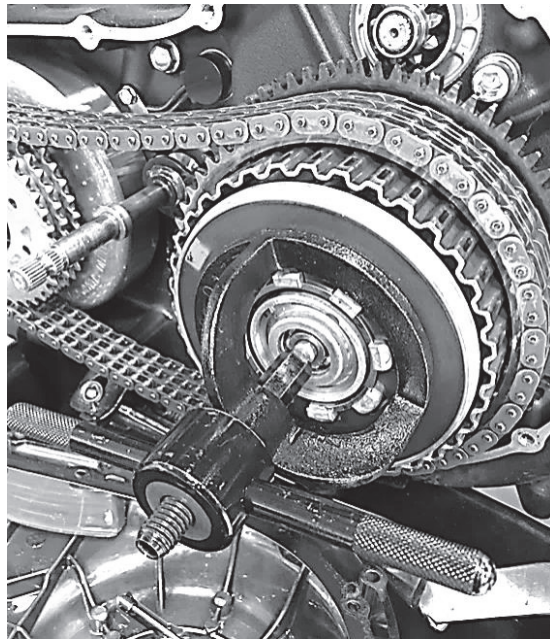

13. Use a 9/16" open-ended wrench to hold the clutch tool shaft in place. Slowly turn the compressor tool handle **clockwise** until the spring is compressed enough to remove the snap ring.

⚠ CAUTION

The spring is loaded. Wear eye protection.

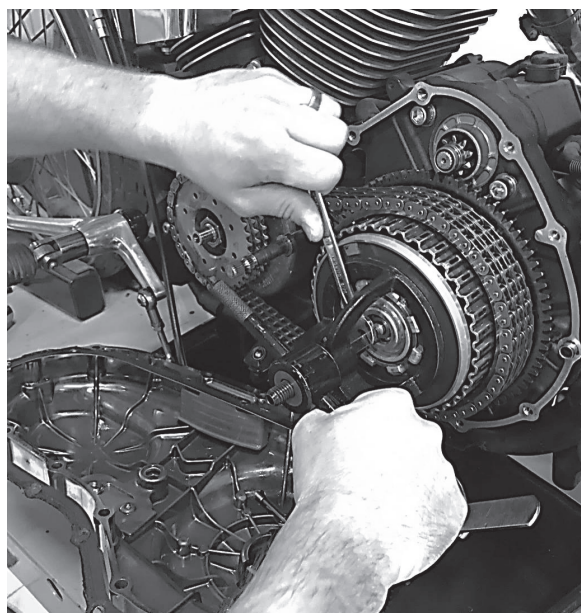

14. Use a pair of pliers to remove and keep the clutch spring retaining ring.

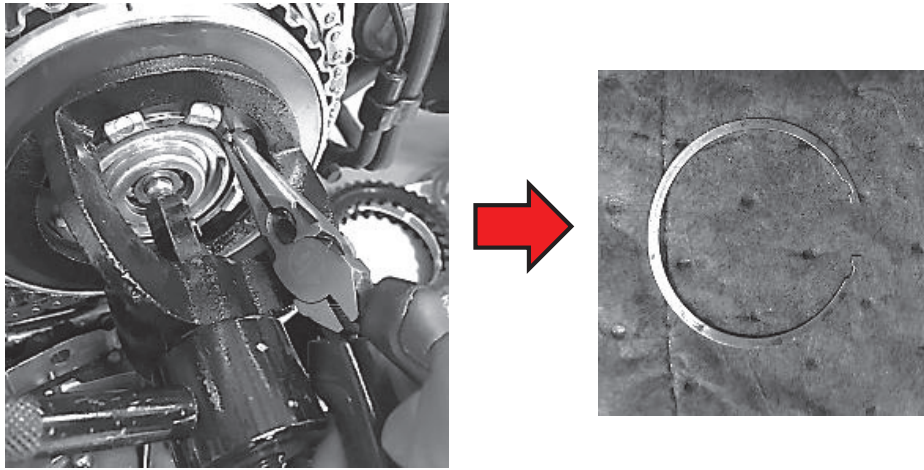

15. Remove the OE clutch Belleville spring and pressure plate and set them on a workbench.

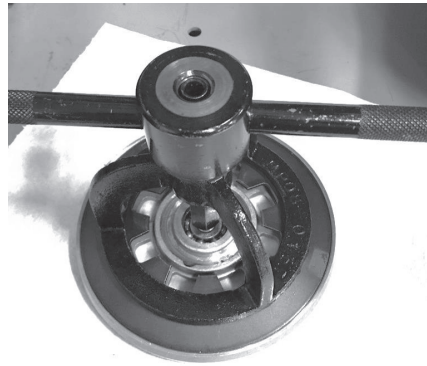

16. Remove the clutch pack from the clutch basket

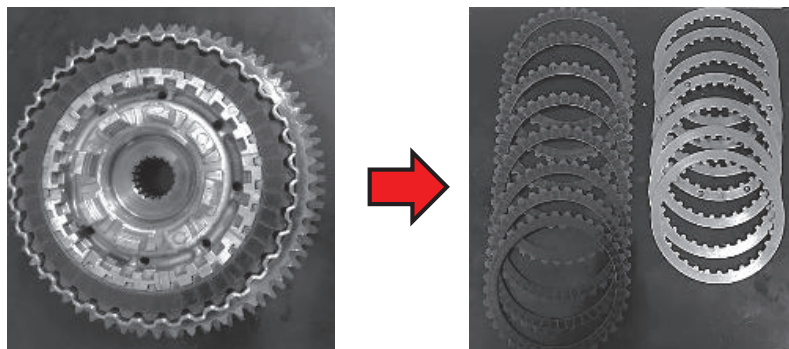

INSTALL THE CLUTCH PACK

1. Install a Rekluse TorqDrive® friction disk 1st into the basket then install a .060" Drive plate alternating with Rekluse TorqDrive friction plate followed by the second .060" drive plate.
2. Continue to alternate Rekluse TorqDrive® friction disks with .048" steel drive plates until all clutch plates have been installed.

The last plate installed will be a Rekluse TorqDrive® friction disk.

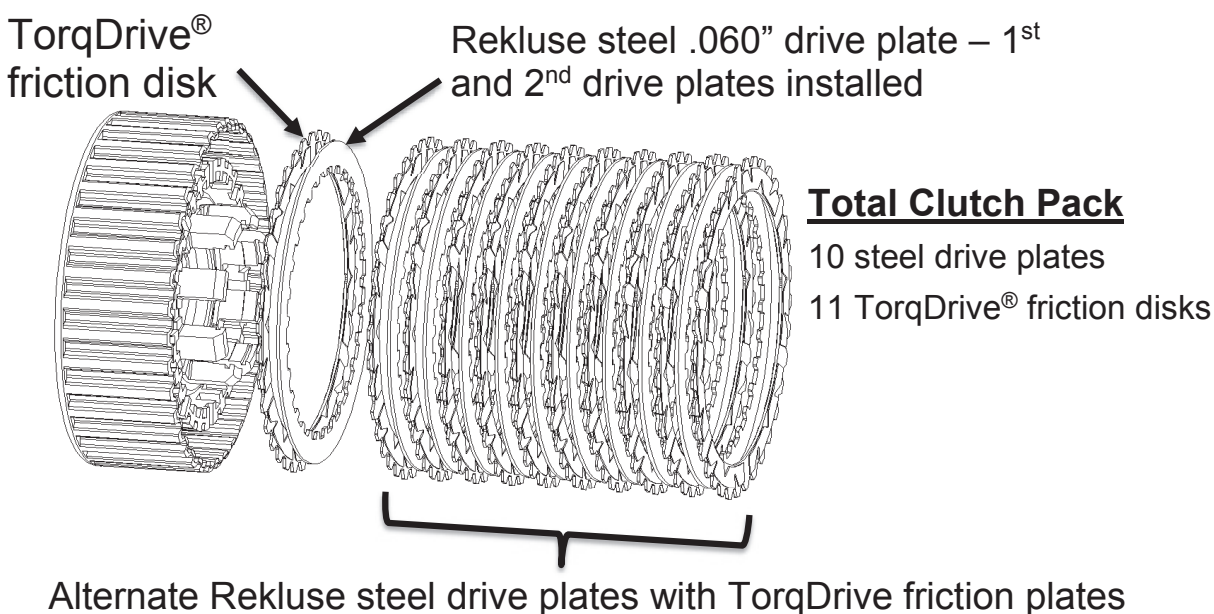

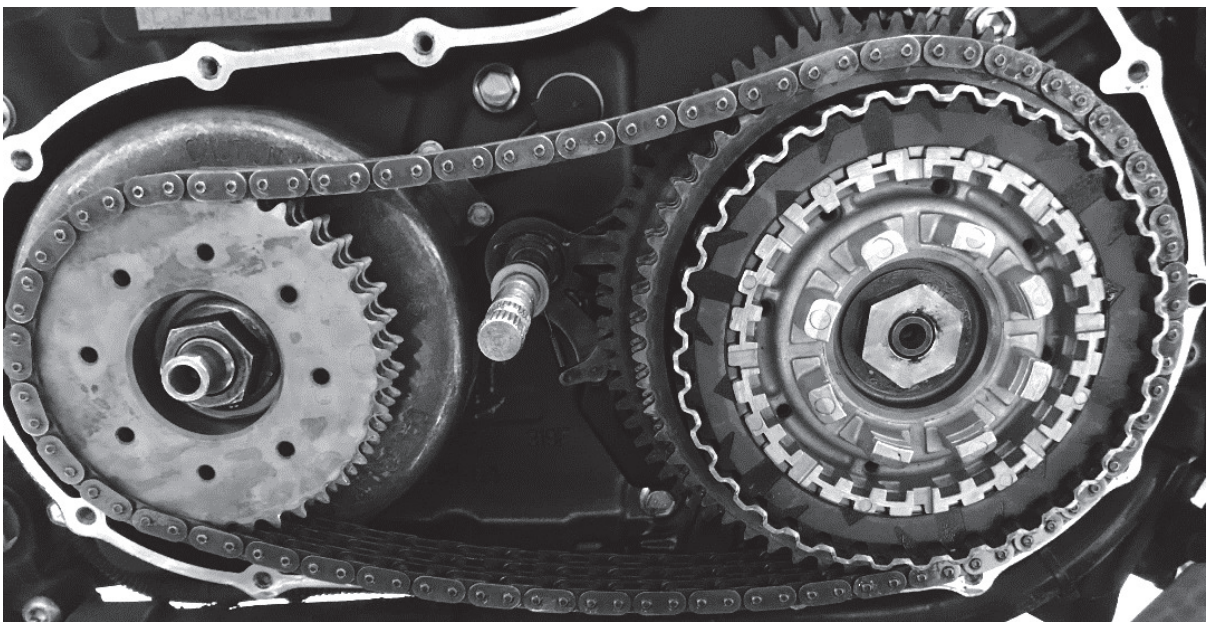

INSTALL THE PRESSURE PLATE

1. Place the pressure plate with clutch spring compressor tool onto the clutch pack.

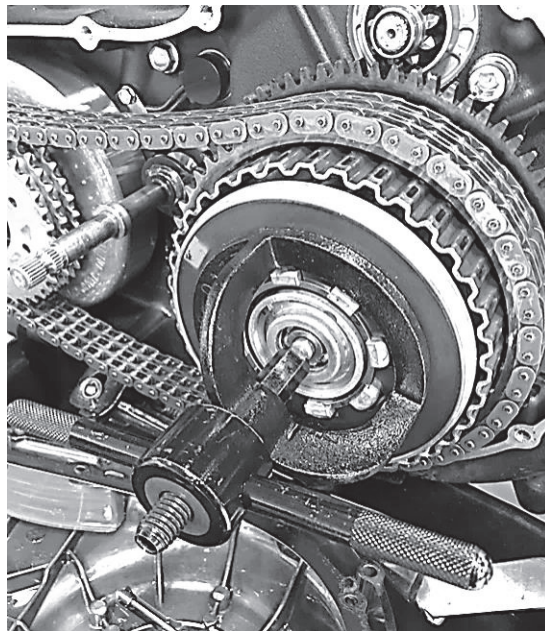

2. Use a pair of pliers to install the clutch spring retaining ring

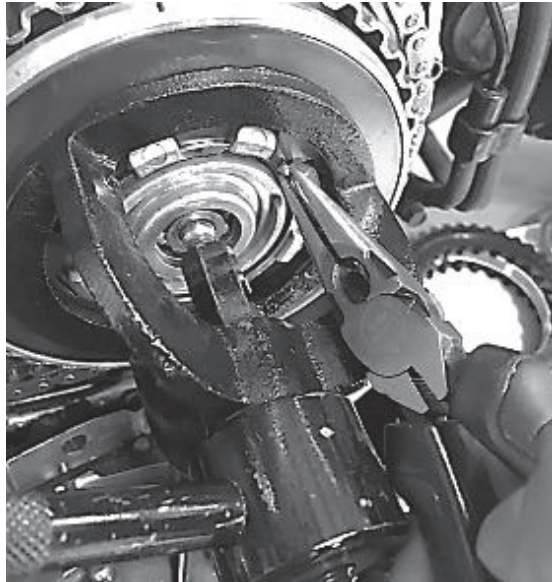

3. After making sure the retaining ring is completely seated in the clutch hub groove, slowly turn the spring compression tool handle counterclockwise while checking that the clutch spring seat lip seats inside the circlip. After all tension has been removed from the compression tool, remove it from the pressure plate.

3. Reinstall the OE primary case gasket. Inspect the OE gasket for signs of wear. If needed, replace with a new OE gasket.

4. Check the inside of the primary case cover to make sure the clutch actuating mechanism is indexed properly into the key slot on the back side of the case.



5. Reinstall the OE primary case cover.

Note: The easiest way to perform this step is by first aligning the shifter shaft with the primary case and sliding it on part-way. Then, lift the drive chain over the chain adjuster and slide the primary case on the rest of the way.

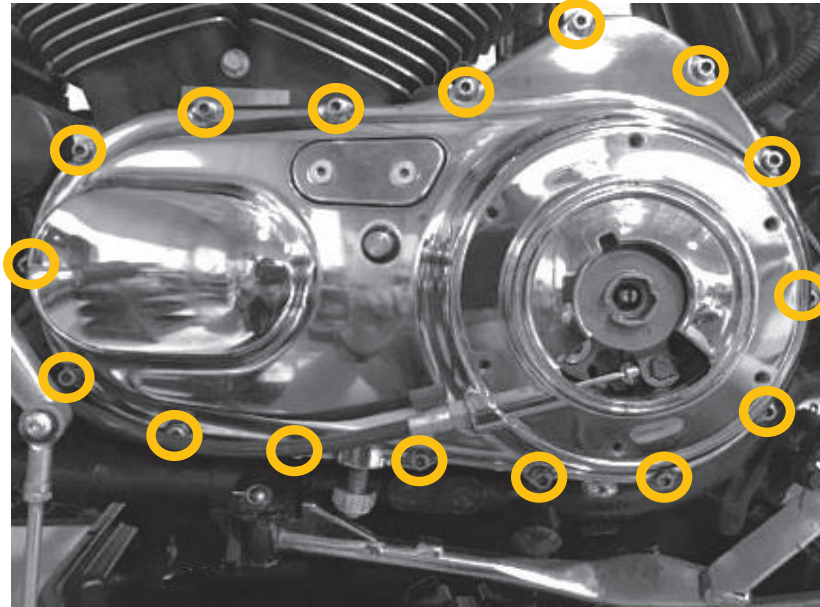

6. Torque the chaincase bolts to **80 in-lb (9 N-m)**.

FINISH INSTALLATION

1. Reinstall the OE threaded nut onto the OE threaded throw-out rod.

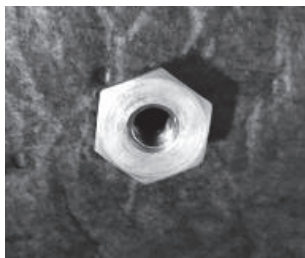

2. Turn the OE throw-out rod **counterclockwise** until you feel firm resistance.

Note: If the lock nut will not fully index, turn the throw-out rod counterclockwise slightly until it fully indexes between the throw-out rod and the slot in the clutch actuating mechanism

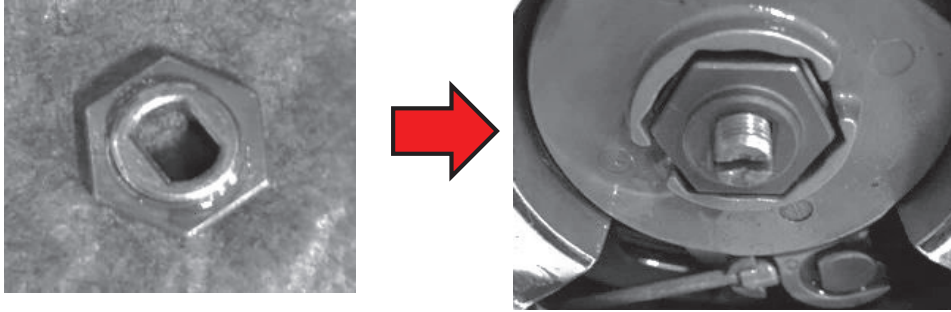

3. Reinstall the OE clutch actuating mechanism spring by pressing it onto the lock nut in the clutch actuating mechanism.

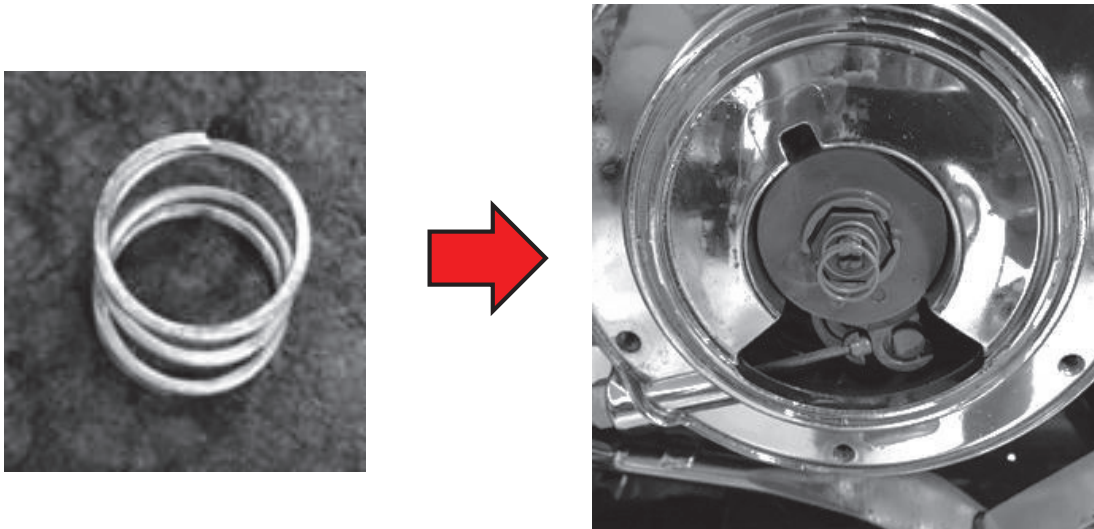

4. Reinstall the gasket for the OE derby cover, then install the derby cover. *Lightly applying grease to the o-ring can help hold it in place when installing the derby cover.*

5. Torque the bolts to **40 in-lb (4.5 N-m)**.

6. Remove and set aside the OE chain inspection cover and gasket.

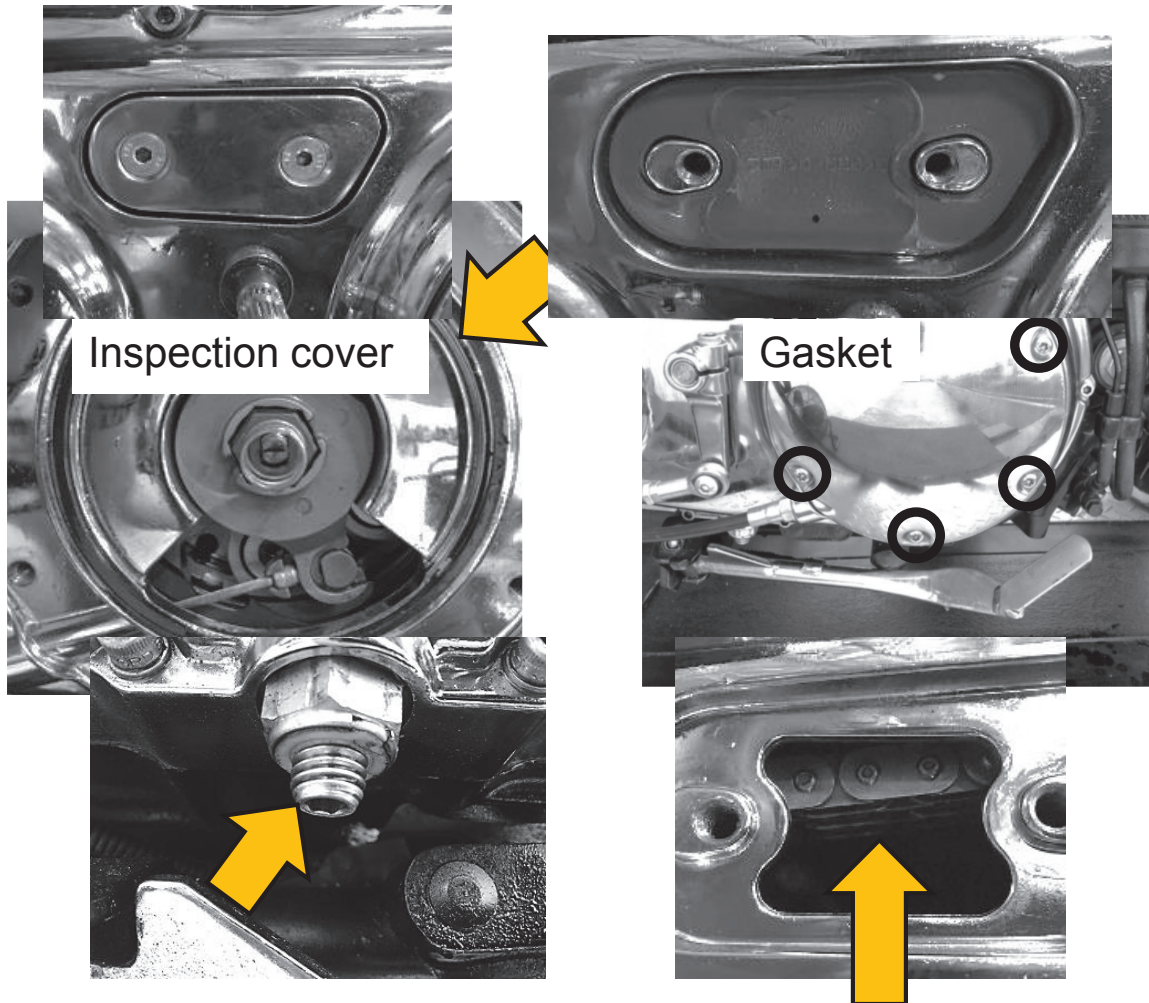

7. Verify that the lock nut on the chain tensioner is still loose. Then, turn the adjustment bolt on the chain tensioner **clockwise** until the drive chain has **3/8"** to **1/2"** of travel in it.

8. Taking care to keep the adjuster bolt from rotating, tighten the lock nut on the chain tensioner to **20 ft-lb (27 N-m)**.

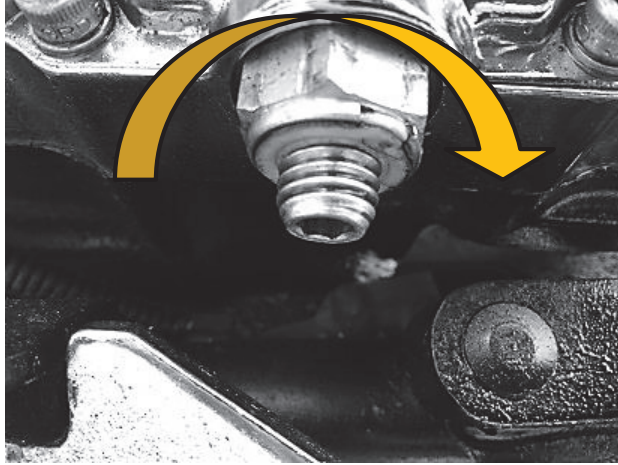

9. Install the oil drain-plug. Torque to **14 ft-lb (19 N-m)**.

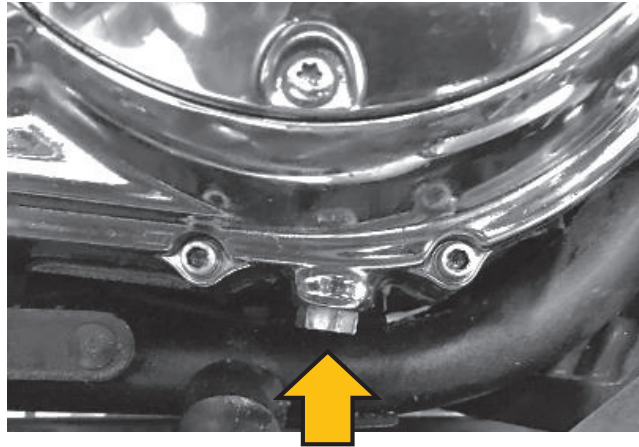

10. Insert a funnel into the inspection window and pour 1 quart of OE recommended oil into the primary chaincase.



11. Reinstall the OE chain inspection cover gasket and inspection cover. Torque the bolts to **40 in-lb (4.5 N-m)**.
12. Reinstall the shift lever onto its shaft followed by the footboards.

RESET THE LEVER FREE PLAY

“Lever free play” is essentially the “slack” in the clutch cable before it starts actuating the clutch. Applying a light finger pressure will take up this slack.

1. Expand the in-line adjuster until the cable slack is between 1/16” and 1/8” at the lever perch.

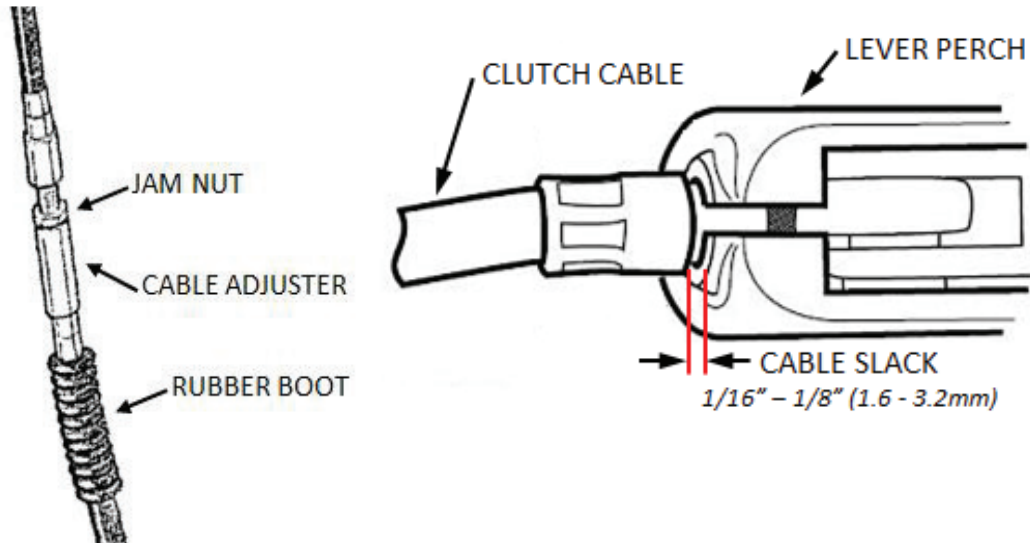

BREAK IN THE NEW CLUTCH

The clutch will break in within 100-200 miles of normal riding. Until break-in is complete, you may experience more clutch drag than normal.

- It is recommended to do an oil change after the first 1,000 miles to drain any excess clutch debris that occurred from break-in.

MAINTENANCE

To keep your clutch performing at its best, perform regular maintenance on your bike and clutch.

- Keep up with regular oil changes according to the bike manufacturer's recommendations. Clutch performance and longevity depend on oil quality.
- Use oil recommended by the manufacture of your bike.
- For optimal clutch performance Rekluse recommends using fresh, clean oil that **meets JASO-MA** oil rating requirements.
- Inspect all of your clutch parts for signs of wear or excessive heat, and replace components as necessary. This includes your basket sleeves. Clutch wear is dependent on the riders use.
- Measuring the friction disks for wear. This can help determine if the components need replacing.
 - Rekluse thin friction disk minimum allowable thickness = **0.068" (1.7 mm)**
 - Wider internal diameter friction disk = **0.116" (2.9 mm)**
- Repeat the break-in procedure anytime you replace the frictions disks. Always soak friction disks in oil for at least 5 minutes before installing.
- Replace friction disks if they measure below specifications or if the disks are glazed and/or burnt.
- Replace the drive plates if they show signs of excessive heat.

Disk inspection examples

When inspecting the clutch pack, the following pictures can be used as a reference. **These are best viewed in color by viewing this install document on www.rekluse.com/support.**

Drive Plates – If the clutch pack is getting high amounts of heat, purple, blue, or black color can be seen on the drive plate teeth. See pictures below. Not all drive plates look the same and may look different than pictured.



Normal Heat

High Heat
(Blue)

Excessive Heat
(Black)

Friction Disks – Due to the dark color of the friction material, the friction disks will appear almost black as soon as they are put in oil. During inspection, look for glazing of the friction material. Glazing will appear shiny and feel like glass, even after oil is cleaned from the friction disk. Not all friction disks look the same and may look different than pictured.



Normal Friction



Glazed Friction

TROUBLESHOOTING

Performance issues

If you find yourself constantly adjusting free play or adjusting for drag, the clutch disks might be worn. Excessive heat or clutch slip can cause premature clutch failure as well. Once extreme temperatures are reached, irreversible damage will occur.

- Inspect all of your clutch parts for signs of wear or excessive heat, and replace components as necessary. Clutch wear is dependent on the riders use.
- Measuring the clutch pack can help determine if the components need replacing.

Clutch Drag:

If drag occurs only while the bike is cold, oil is the most likely cause. Be sure to warm up the bike before riding and/or racing. Use of lighter weight oil can help to minimize cold drag.

Clutch Slip:

If clutch slip occurs, inspect the clutch for signs of wear or heat.

NEED ADDITIONAL HELP?

Website

www.rekluse.com/support

Frequently Asked Questions

www.rekluse.com/faq

Support Videos

www.rekluse.com/support/videos

Phone

(208) 426-0659

Technical Support

Contact Technical Support for questions related to product installation, tuning, and performance.

Technical Support hours:

Monday thru Friday: 8:00 a.m. - 5:00 p.m.

Mountain Time zone

Email: tech@rekluse.com

Customer Service

Contact Customer Service for additional product information, orders, and returns.

Customer Service hours:

Monday thru Friday: 8:00 a.m. - 5:00 p.m.

Mountain Time zone

Email: customerservice@rekluse.com



198-2815006 SETUP SHEET

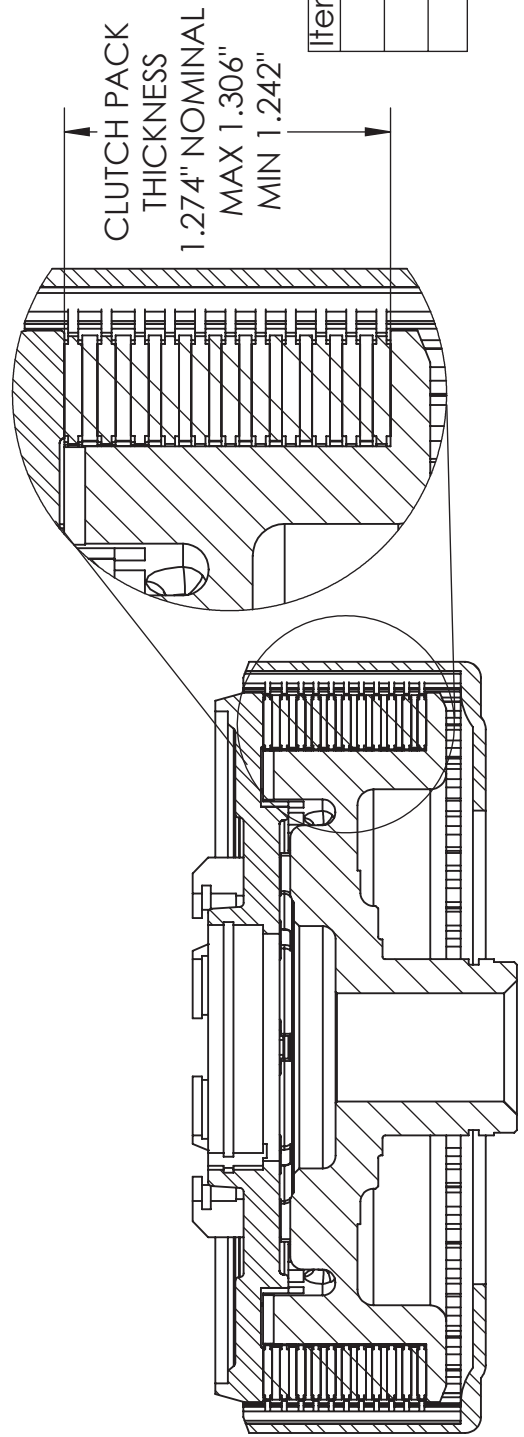
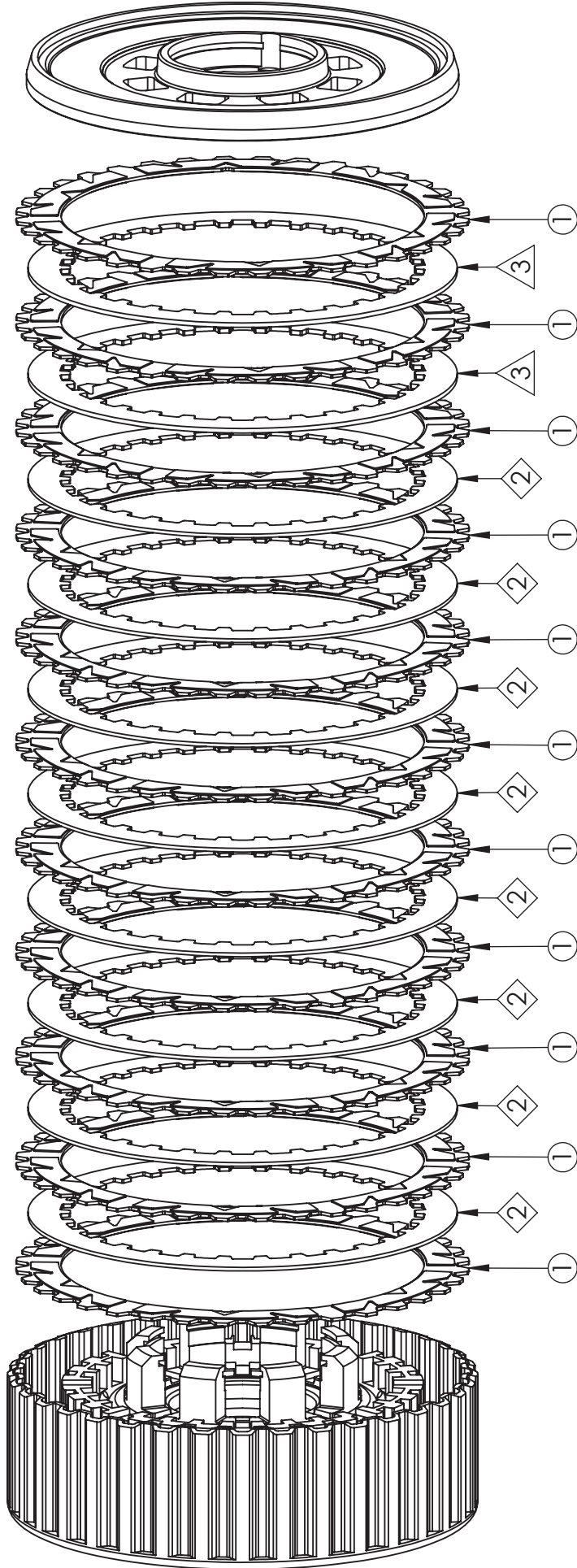

Item No.	Description	Qty
1	TORQDRIVE FRICTION	11
2	.048" THICK DRIVE PLATE	8
3	.060" THICK DRIVE PLATE	2